



4x3 Heritage Shed - (Dark Grey Trim) English SS587

Assembly Instructions

Before assembly

- We recommend that time is taken to read the instructions before starting assembly, then follow the easy step by step guide. The instruction sheet is only a guide to the assembly. Certain items may not be shown to scale.
- Check all components prior to assembly
- This product should be assembled by no less than two people
- Drill all components where indicated



Recommended tools for assembly

- Power drill/screwdriver
- 3mm drill bit
- 6mm drill bit
- Crosshead screwdriver bit
- Hammer
- Spirit level
- Sharp knife

No.	Components	Qty.
1	Floor (1174 x 882mm)	1
2	Front panel	1
3	Door	1
4	Weatherstrip	1
5	Back panel	1
6	Side panel	2
7	Roof purlin (28 x 45 x 882mm)	1
8	Roof panel (700 x 940mm)	2
9	Roof rafter	2
10	Felt batten	2
11	Roof felt	1
12	Coverstrips (12 x 40 x 1615mm)	4
13	Bargeboards	4
14	Finials	2

No.	Fixing Kit	Qty.
15	T-hinge (Black 254mm)	3
16	Pad bolt (Black)	1
17	Turn button (Black)	1
18	50mm bolts	4
19	Washers	4
20	Nuts	4
21	63mm screws	2
22	50mm screws	23
23	25mm screws (Black)	28
24	30mm nails	60
25	10mm Felt nails	36

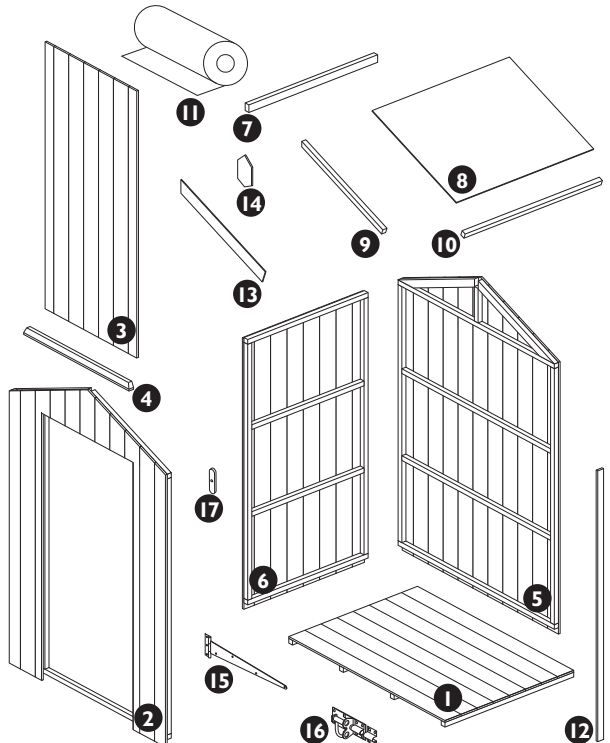
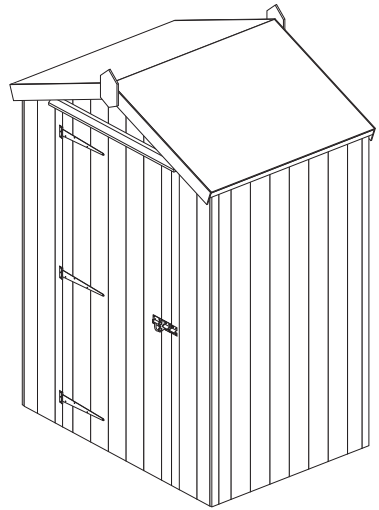

1. Floor

Prepare a level area for the shed to sit. Attach three treated wooden or similar bearers of size 50 x 50 x 1175mm to each floor panel (Not supplied in kit). Position the floor on the prepared area and ensure level.

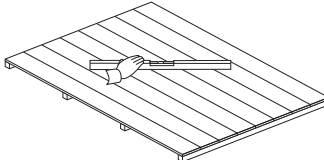

To **VALIDATE** the guarantee, this item should be erected on 50mm x 50mm treated wooden or similar bearers (**These are not supplied with the kit.**) Ground contact must be avoided.

2. Front panel

Lay the front panel on a clean soft surface. Place the door into position. Fix the three T-hinges to the door with 4 x 25mm screws per hinge. Secure the hinges to the door frame using 3 x 25mm screws per hinge. Fit the turn button to the door panel as shown using 1 x 25mm screw. Fit the padbolt to the door using 4 x 25mm screws and 2 x 50mm coach bolts, nuts and washers. It will be necessary to drill holes for the coach bolts using a 6mm diameter drill bit. Fit the catch plate to the front panel, Ensure the bolt is able to slide into the catch plate, attach using 2 x 25mm screws and 2 x 50mm coach bolts, nuts and washers, as shown below. Fix the weather strip above the door, using 3 x 50mm screws. Screw through the frame of the front panel into the strip.

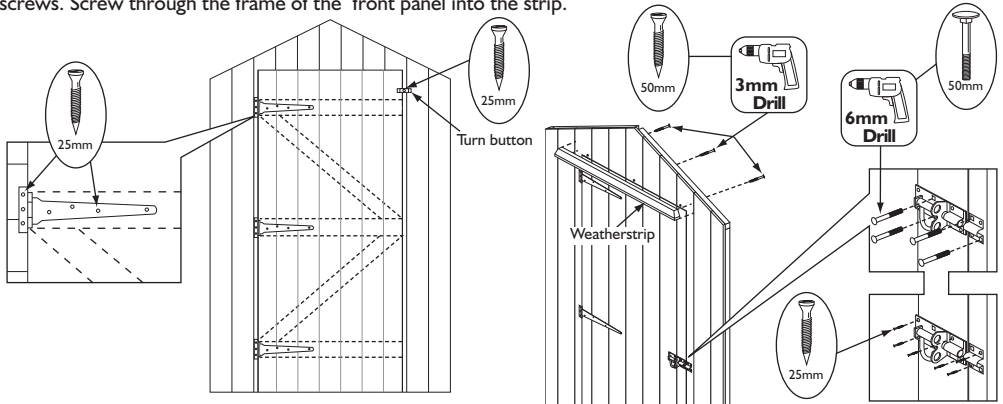

3. Wall panels

Position the back panel and a side panel on the floor as shown. Note how the panel frames sit on the floor with the panel cladding overhanging the floor edge. Ensure square and secure using 3 x 50mm screws, screw through the frame of the side panel into the frame of the back panel. Attach the other side panel and front panel in the same way.



It is recommended to drill pilot holes for each screw before assembly.

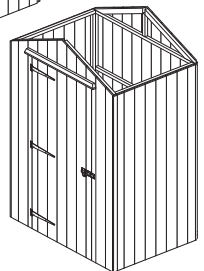
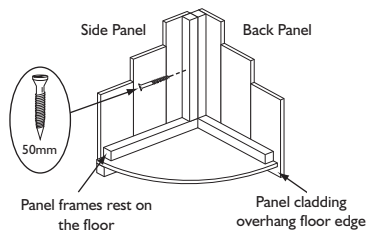
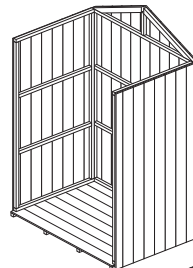
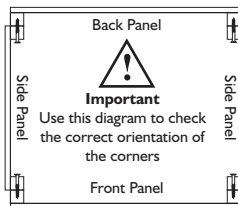
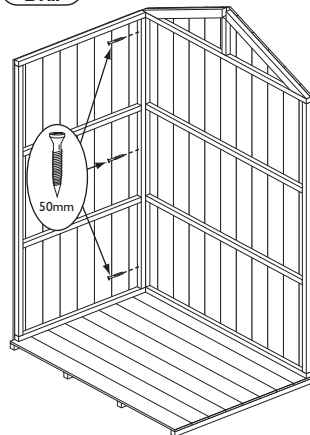

4. Securing the walls to the floor

Ensure the panels are sitting square on the floor. Secure each side panel with 2 x 50mm screws, screw through the panel frames into the floor. Secure the front and rear panels using 2 x 50mm screws per panel, screw through the panel frames and floor into the centre floor joists.



It is recommended to drill pilot holes for each screw before assembly.

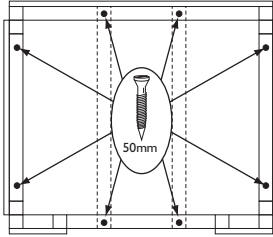

5. Roof

Insert the roof purlin into the gap at the apex of the front and back panel framing, secure in place using 2 x 63mm screws. Secure a felt batten and a roof rafter to each roof panel using 4 x 30mm nails as shown. Ensure the felt batten is flush to the edges of the panels. Position the roof panels onto the assembly, make sure the top edges are located at the apex and the roof is flush to the back to the body of the shed. Secure the panels in place using 8 x 30mm nails per panel. Nail through the roof into the wall panel frames.

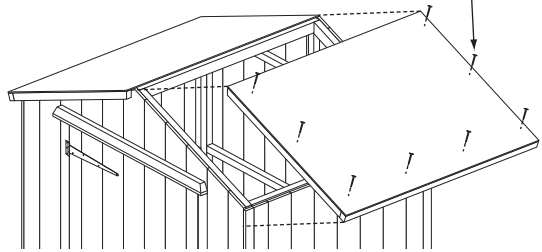
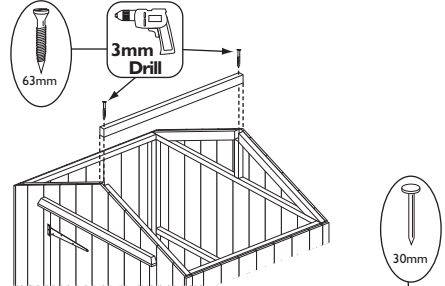
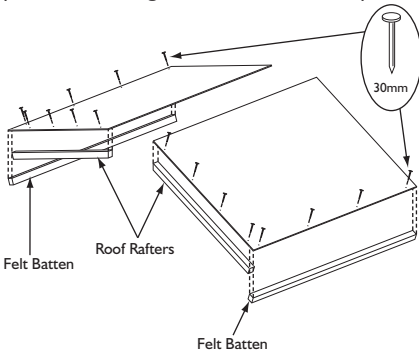

6. Roof felt

Lay the roof felt centrally over the roof. On one side fold over the felt so it covers the felt batten and secure to the batten using 12 x 10mm felt nails. Tension the felt over the roof and fold the felt over the other felt batten and secure using 12 x 10mm to the batten. Dress the felt down at the front and back and secure each using 6 x 10mm felt nails. If necessary trim off any excess felt.

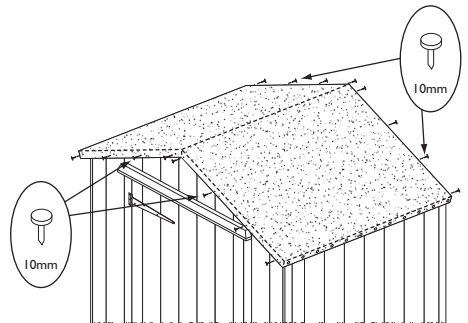
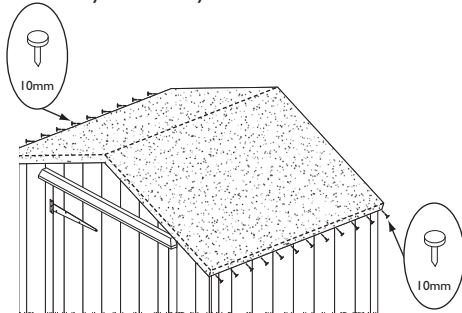

6. Coverstrips, bargeboards & finials

Fit a coverstrip into each corner, attach using 3 x 30mm nails per strip. To the front and rear of the shed, secure the bargeboards so that the top edge is flush with the roof line and the two boards meet evenly at the apex. Secure using 3 x 30mm nails per board. At the front and rear of the assembly, attach the finials at the apex over the joint between the bargeboards using 2 x 30mm nails per finial.

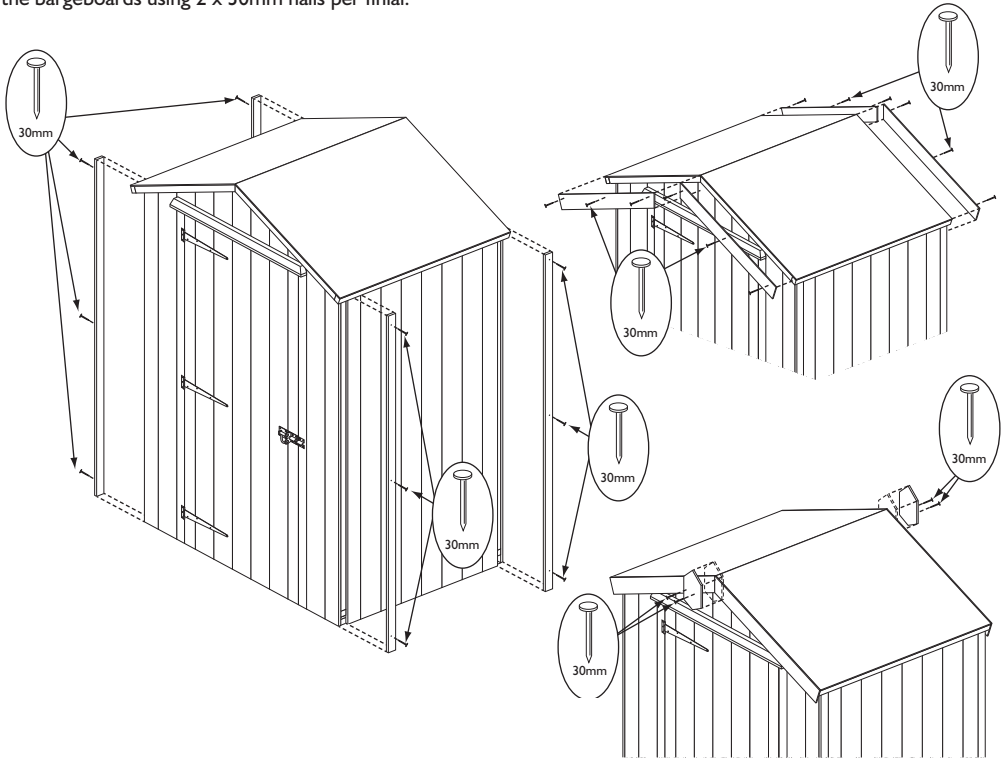

Important information

Rowlinson Heritage buildings come ready painted. To maintain the effective waterproofing of the treatment and to VALIDATE the guarantee, the building must be properly treated with a recognised external wood preserver EVERY TWO YEARS. The building MUST also be erected on pressure treated wooden 50mm x 50mm or similar bearers (These are not supplied in the kit).

As timber is a natural material, there are certain weather conditions that may affect the materials properties. In times of excessive dry spells the material may lose some of its internal moisture causing a certain degree of shrinkage on a panel and in periods of excessive rain there will be a certain amount of swelling throughout the wooden panels. This process can not be avoided. If you have problems with certain boards shrinking in dry spells try to decrease the amount of direct sunlight on the building or the amount of air passing over the building. During hot spells spray water directly onto the panels with the aid of a garden hose.

If in doubt of any aspect regarding the assembly, use or safety of your garden shed please contact us:

Help Line: (Normal Office Hours) 01829 261 121

Email: support@rowgar.co.uk

ROWLINSON GARDEN PRODUCTS LIMITED
Green Lane
Wardle Nr. Nantwich
Cheshire
CW5 6BN
www.rowgar.co.uk

We constantly improve the quality of our products, occasionally the components may differ from the components shown and are only correct at time of printing. We reserve the right to change the specification of our products without prior notice.

2022 © Rowlinson Garden Products Ltd