

Assembly Instructions

Before assembly

- We recommend that time is taken to read the instructions before starting assembly, then follow the easy step by step guide. The instruction sheet is only a guide to the assembly. Certain items may not be shown to scale.
- Check all components prior to assembly
- This product should be assembled by no less than two people
- Drill all components where indicated



Recommended tools for assembly

- Power drill/screwdriver
- 3mm drill bit
- 6mm drill bit
- Crosshead screwdriver bit
- Hammer
- Spirit level
- Sharp knife

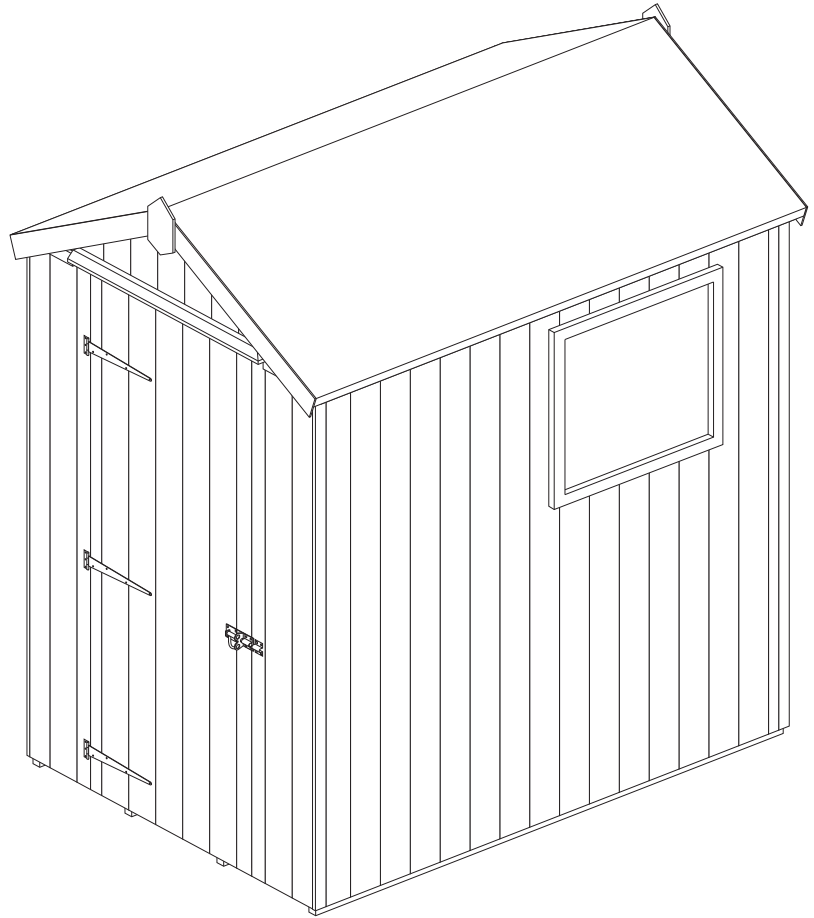

No.	Components	Qty.
1	Floor (1770 x 1174mm)	1
2	Large wall panel (width 1174mm)	2
3	Small wall panel (width 540mm)	2
4	Window panel	1
5	Left-hand front panel	1
6	Right-hand front panel	1
7	Apex panel	2
8	Door header rail (29 x 29 x 647mm)	1
9	Roof purlin (29 x 29 x 1770mm)	2
10	Roof panel	2
11	Roof rafter	4
12	Door	1
13	Roof felt roll (4m)	1
14	Weatherstrip	1
15	Rear apex joint coverstrip	1
16	Front apex joint coverstrips	2
17	Window frame	1
18	Glazing (563 x 520mm)	1
19	Window beading (15 x 15 x 469mm)	2
20	Window beading (15 x 15 x 565mm)	2
21	Corner coverstrips (12 x 40 x 1725mm)	4
22	Bargeboards	4
23	Finial	2

No.	Fixing Kit	Qty.
24	T-hinge (Black 254mm)	3
25	Pad bolt (Black)	1
26	Cabinet hinge	2
27	Turn button (Black)	1
28	Window stay	1
29	50mm bolt	4
30	Washers	4
31	Nuts	4
32	63mm screws	10
33	50mm screws	43
34	32mm screws	28
35	25mm screws	20
36	25mm screws (Black)	28
37	30mm nails	35
38	25mm nails	12
39	10mm Felt nails	81

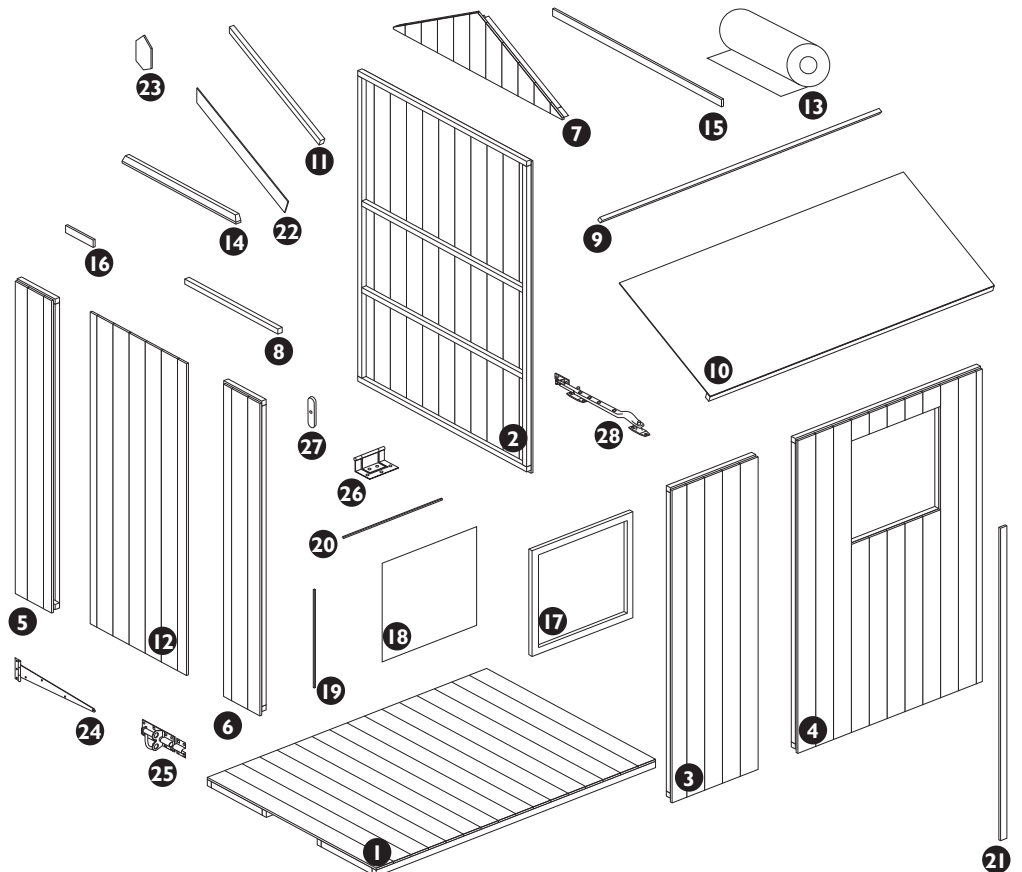

1. Floor

Prepare a level area for the shed to sit. Attach five treated wooden or similar bearers of size 50 x 50 x 1175mm to the floor panel (Not supplied in kit). Position the floor on the prepared area and ensure level.

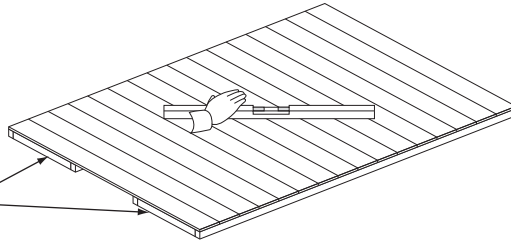

Important
Note the floor framing at one end. This must be positioned at the door end of the shed.



To **VALIDATE** the guarantee, this item should be erected on 50mm x 50mm treated wooden or similar bearers (**These are not supplied with the kit.**) Ground contact must be avoided.

2. Opening Window

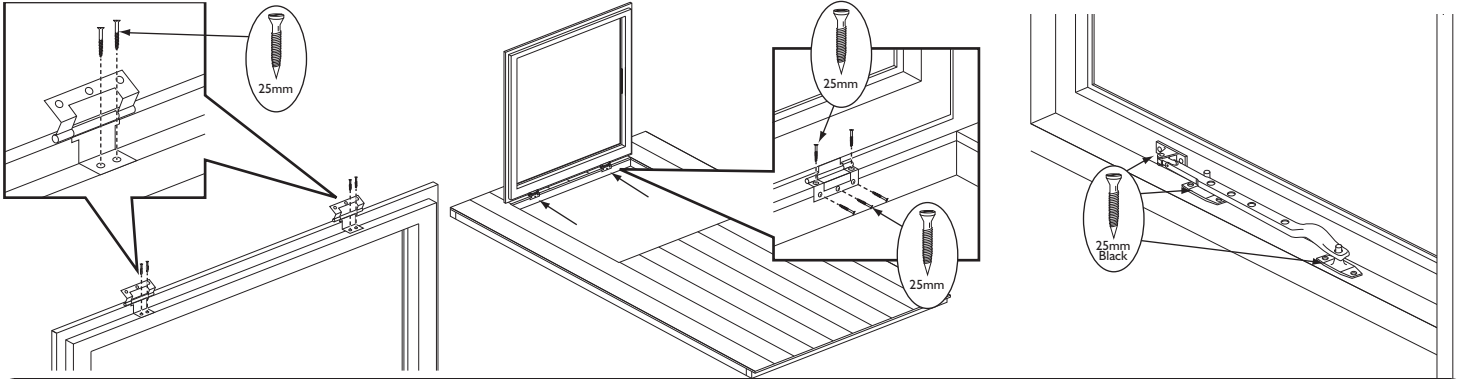
Lay the window panel on the floor. Fit the hinges in the rebates on the longer edge of the window frame as shown in the diagram using 2 x 25mm screws per hinge, stand the hinge end of the window on the window panel, making sure it is centred at the top of the window opening. Open the hinges and secure them to the window panel frame using 5 x 25mm screws per hinge. On the inside of the window panel fit the window stay and its two posts using 6 x 25mm screws as shown in the diagram.



3. Wall panels

Position a large panel and a small side panel on the floor as shown. Note how the panel frames sit on the floor with the panel cladding overhanging the floor edge. Ensure square and secure using 3 x 50mm screws, screw through the frame of the small side panel into the frame of the back panel. Continue to add the remaining panels in the same way, in the order shown below.



It is recommended to drill pilot holes for each screw before assembly.

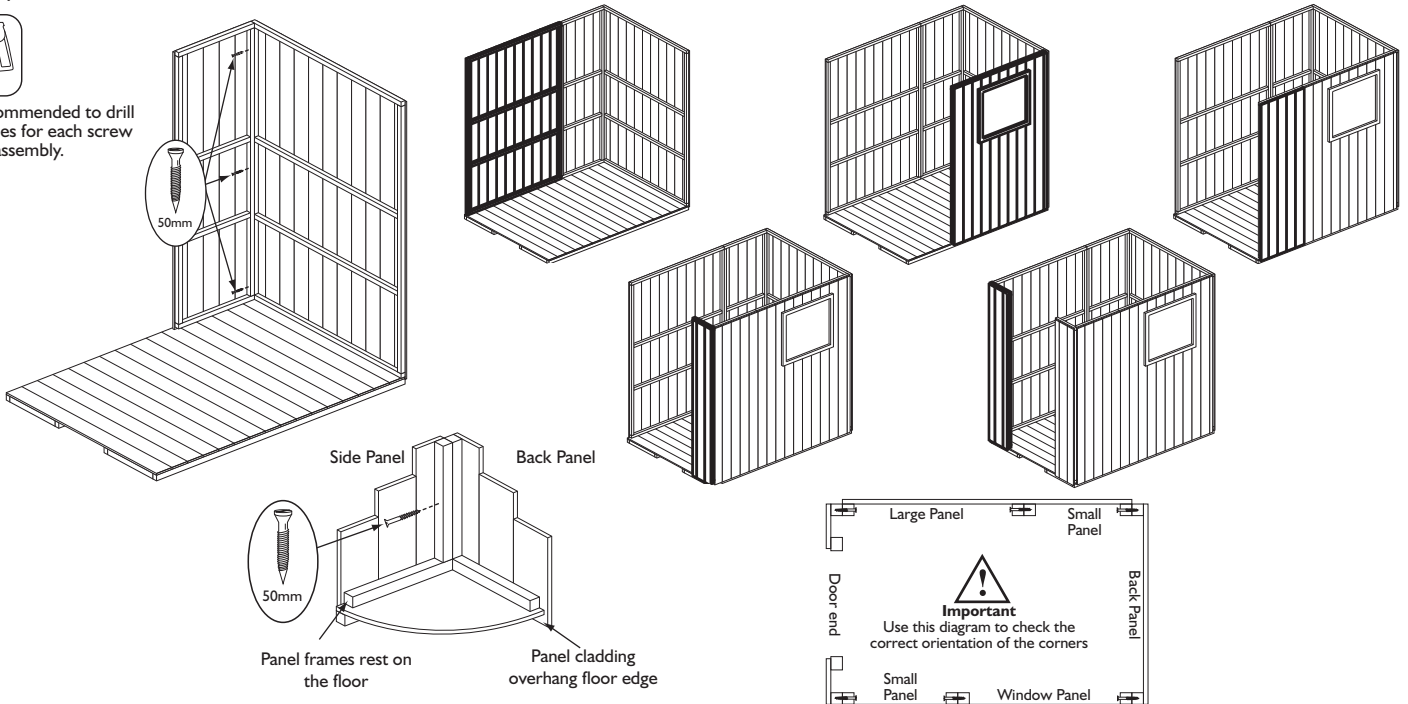

4. Apex panels

Place an apex panel on top of the back panel and secure using 2 x 50mm screws, screw up through the top frame of the back panel into the bottom frame of the apex panel. Attached the front apex in the same way. Fix to the frame of the front apex, the door header rail using 2 x 50mm screws. Secure it flush to the bottom of the apex framing. Fix the weatherstrip to the apex panel above the door, use 3 x 50mm screws. Screw through the frame of the apex panel into the weatherstrip.



It is recommended to drill pilot holes for each screw before assembly.

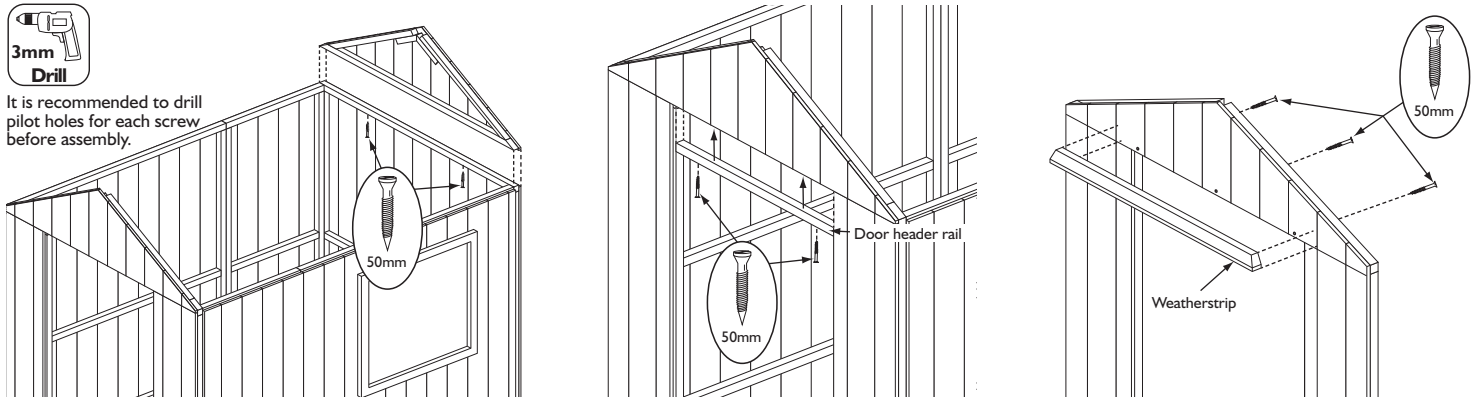

5. Securing walls to the floor

Ensure the panels are sitting square on the floor. Secure using 10 x 63mm screws, screw through the panel frames and floorboards into the floor frames.



It is recommended to drill pilot holes for each screw before assembly.

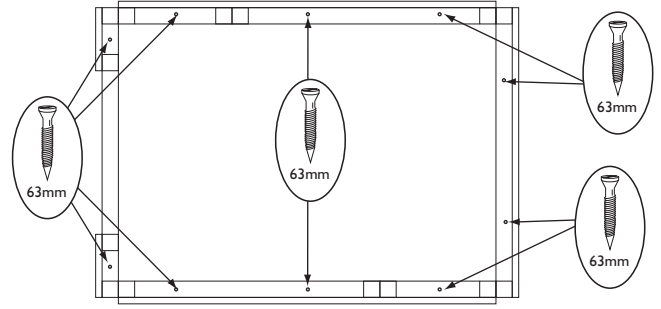
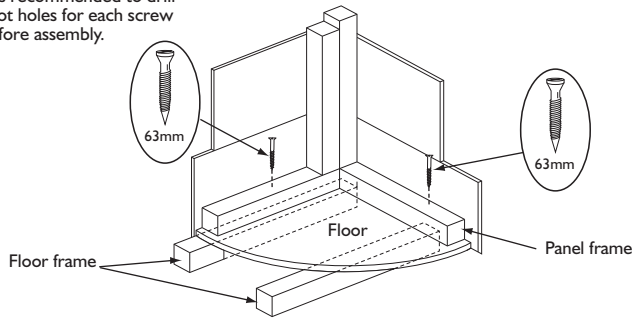

6. Roof Purlins panels and rafters

Insert the two roof purlins into the rebates in the apex panels as shown. Fix each purlin in place using 1 x 50mm screws at the top of each one. Screw through the purlin into the frame of the apex panels. Position the roof panels onto the assembly, make sure the top edges are located at the apex and the roof is flush with the front and back apex. Secure with 12 x 30mm screws per roof section, screw through the roof and into the panel framing and purlins. On both front and rear of the building, secure two roof rafters with the top edges flush with the roof line and the two rafters meeting evenly at the apex. Secure each rafter using 3 x 30mm screws.



It is recommended to drill pilot holes for each screw before assembly.

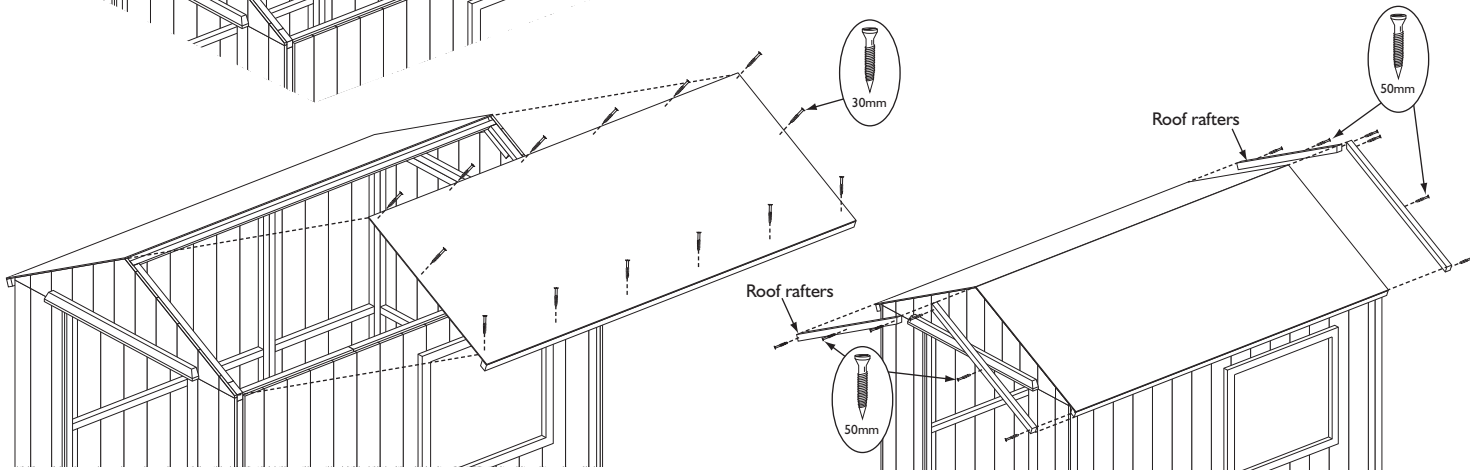
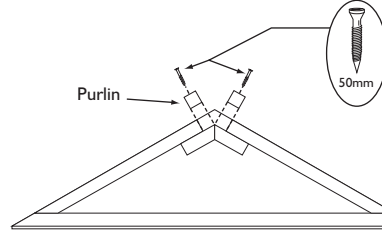
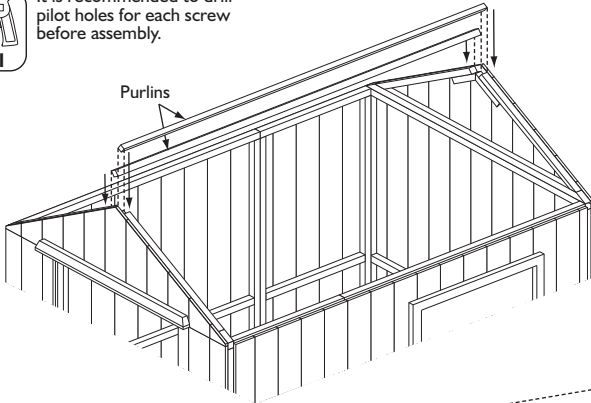

7. Roof felt

Cut roofing felt into two equal lengths. Place one length over the roof. At the front, back and along the lower edge of the roof leave an overhang of felt of at least 40mm. Fold down the felt along the lower edge and secure to the felt batten using 20 x 10mm felt nails evenly spaced. Dress the felt over the roof ridge, tension and secure along the edge using 4 x 10mm felt nails. Position the second piece of felt in the same way as the first on the other side of the roof, ensure it overlaps the first. Attach to the felt batten using 20 x 10mm felt nails, tension over the roof and secure with 20 x 10mm felt nails. At each end dress down the felt and secure to the rafters using 8 x 10mm felt nails per end. Using a sharp knife trim off excess felt.

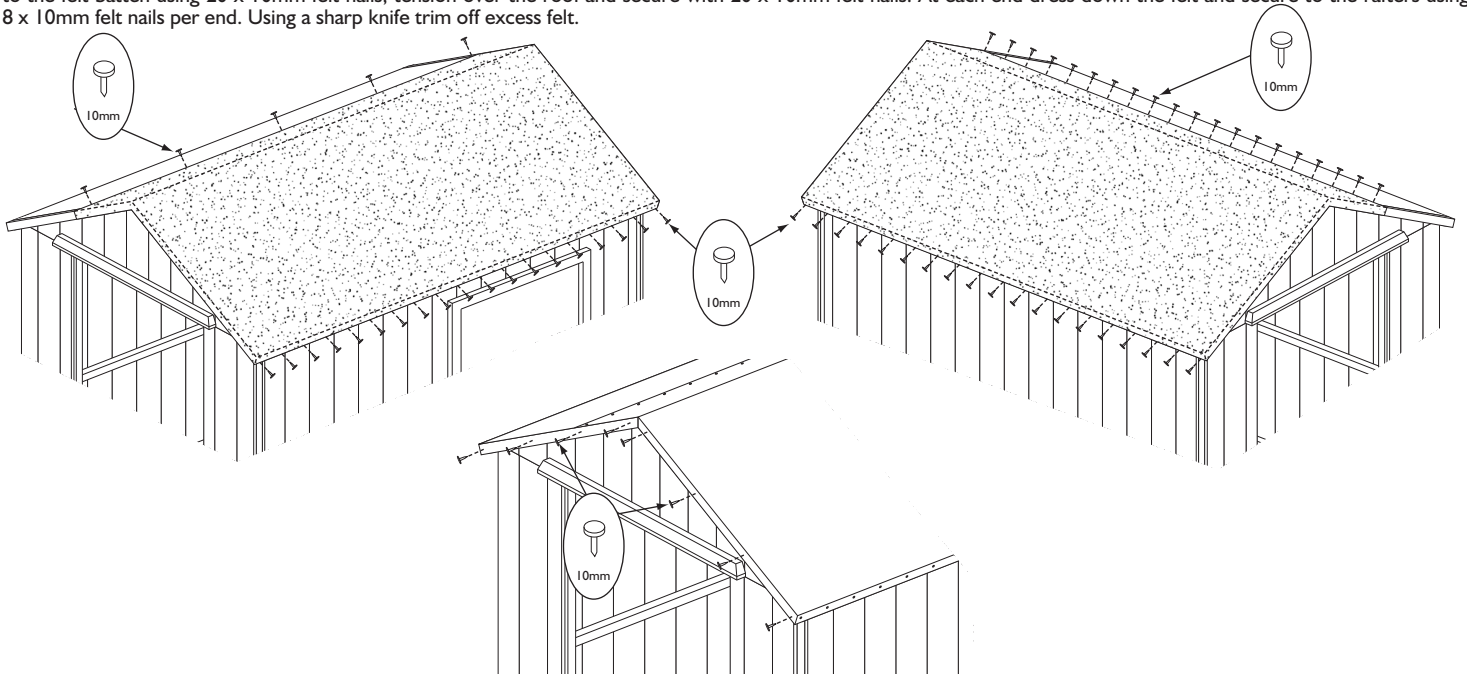

8. Door

Place the door into position. Align the hinges with the three door braces, secure the T-hinges to the door with 4 x 25mm black screws per hinge. Secure the hinges to the door panel using 3 x 25mm black screws per hinge. Fit the turn button to the door panel as shown using 1 x 25mm black screw. Fit the padbolt to the door using 4 x 25mm screws and 2 x 50mm coach bolts, nuts and washers. It will be necessary to drill holes for the coach bolts using a 6mm diameter drill bit. Fit the catch plate to the front panel. Ensure the bolt is able to slide into the catch plate, attach using 2 x 25mm screws and 2 x 50mm coach bolts, nuts and washers.

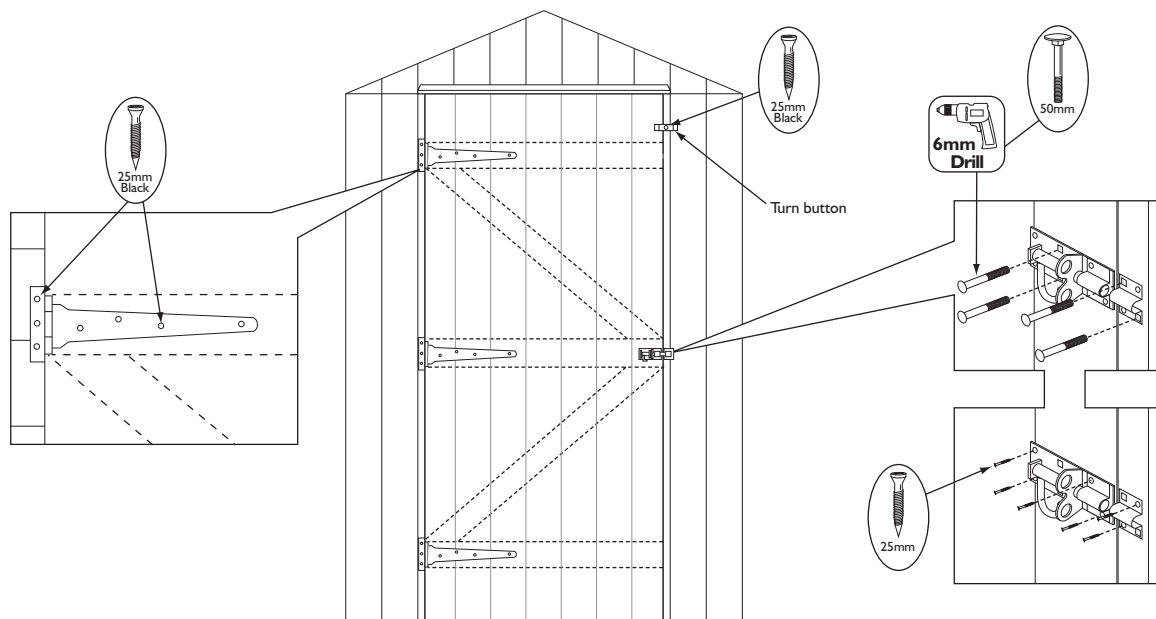

9. Coverstrips, bargeboards, finials and glazing

Fit a coverstrip into each corner, attach using 3 x 30mm nails per strip. To the rear of the shed attach the apex panel coverstrip over the join of the two panels using 3 x 30mm nails. On the front attach each short apex coverstrip with 2 x 30mm, position over the panel join either side of the weatherstrip. On both front and rear of the building, secure two bargeboards with the top edges flush with the roof line and the two boards meeting evenly at the apex. Secure each board using 3 x 30mm nails. Fit the finials at the apex over the join between the bargeboards using 2 x 30mm nails per finial. It is recommended that a waterproof sealant is applied around the edge of the glazing before fitting. Place window glazing into the rebate on the inside of the window frame, nail the four beading strips into position using 3 x 25mm nails per strip.

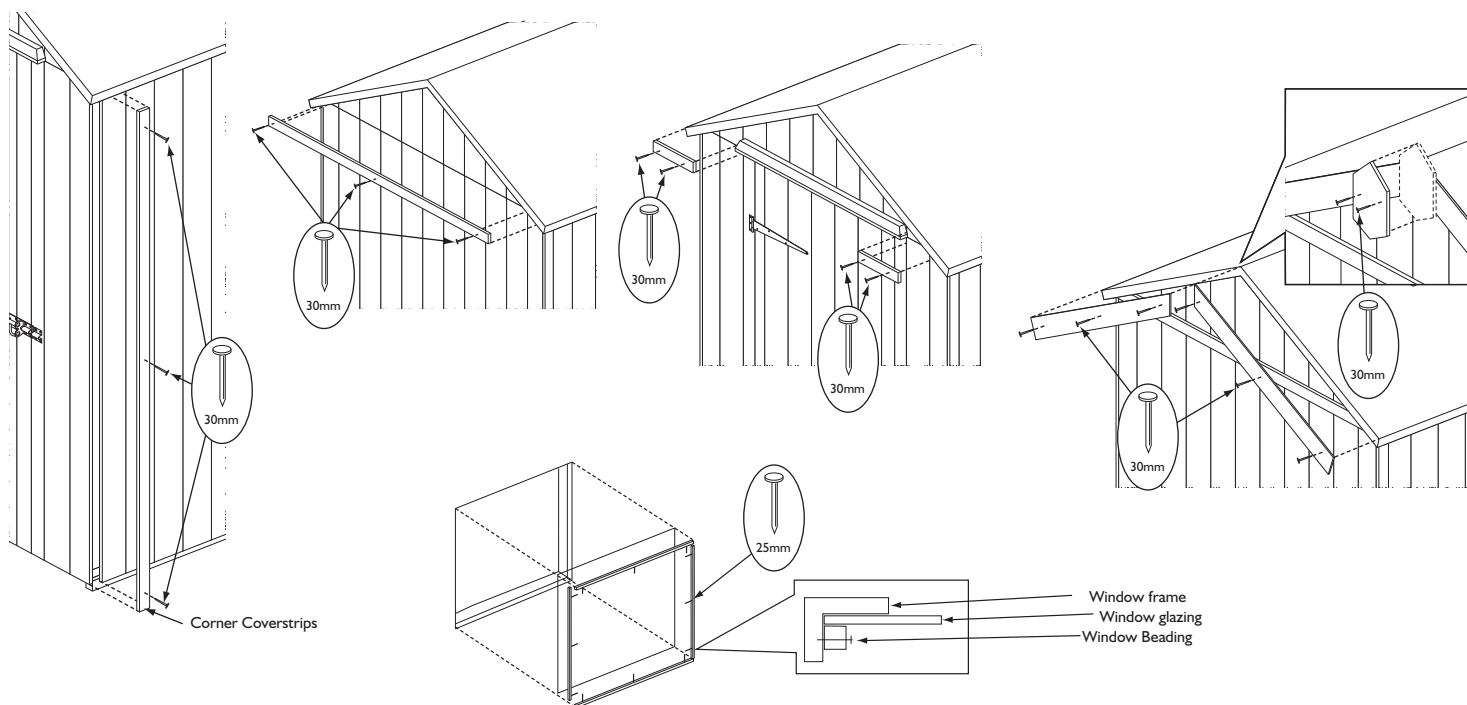

Important information

Rowlinson Heritage buildings come ready painted. To maintain the effective waterproofing of the treatment and to VALIDATE the guarantee, the building must be properly treated with a recognised external wood preserver EVERY TWO YEARS. The building MUST also be erected on pressure treated wooden 50mm x 50mm or similar bearers (These are not supplied in the kit).

As timber is a natural material, there are certain weather conditions that may affect the materials properties. In times of excessive dry spells the material may lose some of its internal moisture causing a certain degree of shrinkage on a panel and in periods of excessive rain there will be a certain amount of swelling throughout the wooden panels. This process can not be avoided. If you have problems with certain boards shrinking in dry spells try to decrease the amount of direct sunlight on the building or the amount of air passing over the building. During hot spells spray water directly onto the panels with the aid of a garden hose.

If in doubt of any aspect regarding the assembly, use or safety of your garden shed please contact us:

Help Line: (Normal Office Hours) 01829 261 121

Email: support@rowgar.co.uk

ROWLINSON GARDEN PRODUCTS LIMITED
Green Lane
Wardle Nr. Nantwich
Cheshire
CW5 6BN
www.rowgar.co.uk

We constantly improve the quality of our products, occasionally the components may differ from the components shown and are only correct at time of printing. We reserve the right to change the specification of our products without prior notice.

2022 © Rowlinson Garden Products Ltd